

ELEVATION

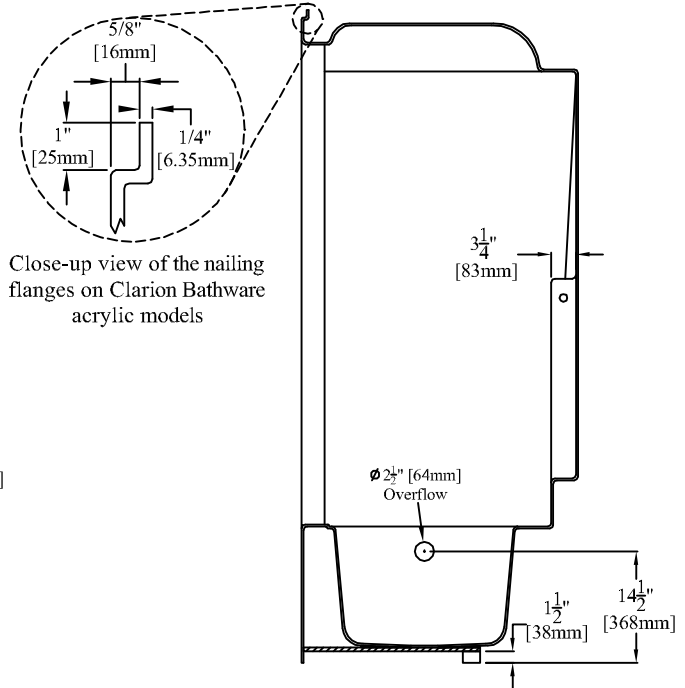

SECTION "A-A"

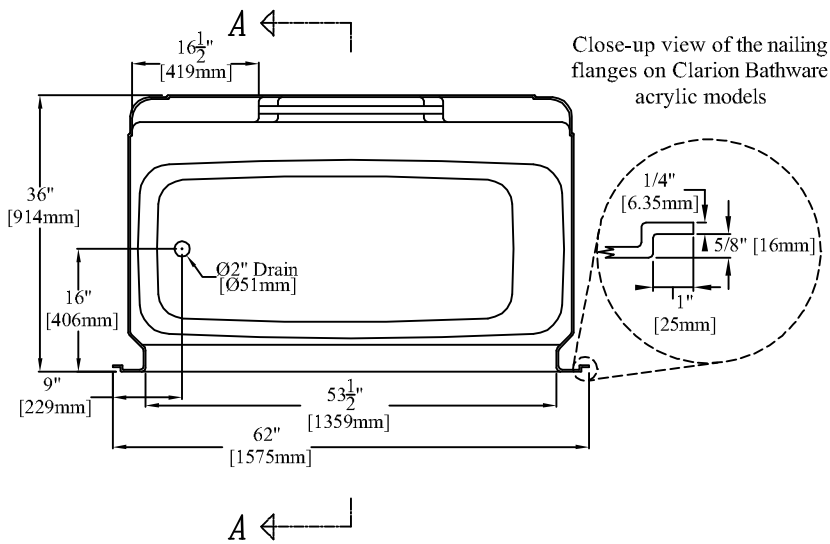

PLAN

62" [1575mm] Acrylic Tub/Shower

Left Hand Version (AR6036TSLT) Shown

PRODUCT SPECIFICATIONS:

- * Product complies with NAHB, HUD UM-73A, and ANSI-Z124.1.
- * Clarion Bathware acrylic products are thermoformed from continuous cast acrylic sheet into a one piece seamless unit.
- * Wood reinforced & slip resistant floor.
- * Molded shelving with factory installed 1" [25mm] clear acrylic towel bar on back wall of unit.
- * Diamond pattern molded into the back wall of the unit.
- * Factory drilled 2 1/2" [64mm] overflow.
- * Door Opening: W-53 1/2" [1359mm]
H-58 1/2" [1486mm]
- * Bathwell Dimensions (At Top): W-55 1/2" [1410mm]
D-23 1/4" [591mm]
H-15 1/2" [394mm]
- * Bathwell Dimensions (At Bottom): W-46 1/2" [1181mm]
D-19" [483mm]
- * Bathwell Capacity (At Overflow): 45 Gallons [170L]
- * Water Level (At Overflow): 11" [279mm]
- * All dimensions +/- 1/4" [6.4mm]
- * Clarion Bathware reserves the right to change design and/or dimensions.

Model AR6036TSLT or AR6036TSRT

60" [1524mm] Acrylic Tub/Shower with Left or Right Hand Drain

Clarion
BATHWARE
44 Amsler Ave.
Shippenville, PA 16254

Phone: (814) 226-5374
Toll Free: (800) 576-9228
Fax: (814) 226-0730
www.clarionbathware.com

Signatures For Approval:

Customer: _____
Arch./Engr: _____
Contractor: _____
Cla. Engr: _____

Date: _____

Dwg. Name:
AR6036TSLT
orTSRT-CUT
Dwg. By: DJC
DATE: 4/1/10